

Article number: 20957426

Description: E+G Levelling foot
GN 343.3-25-M8-A

Measures

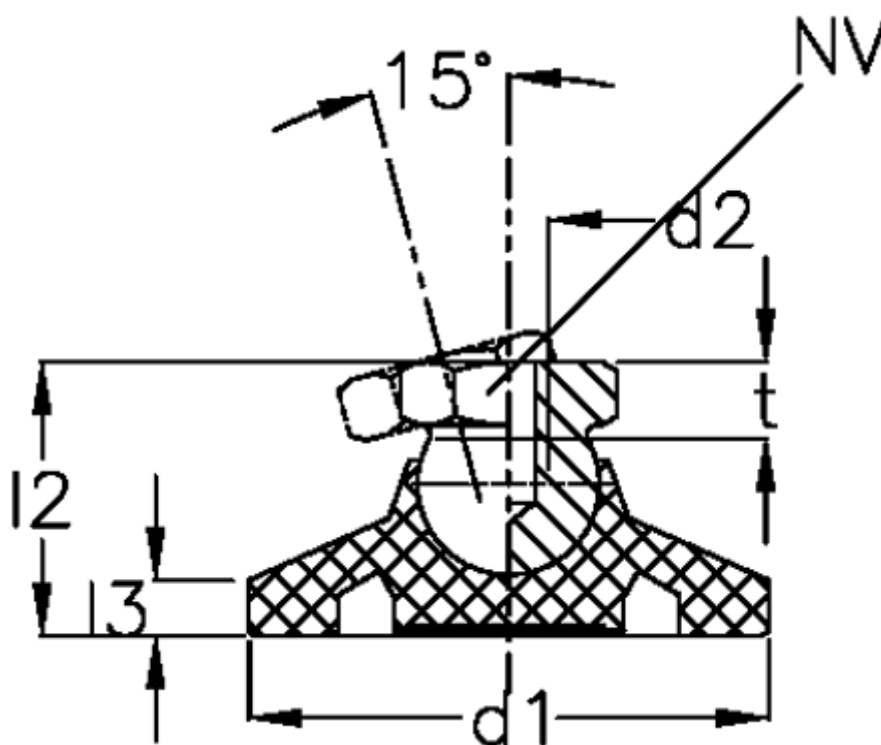

d1	= 25
d2	= M 8
l2	= 18.5
l3	= 4.0
NV	= 12.0
Static load (N)	= 5000
t min	= 9.0